

# Wireless Pool Thermometer

## User Manual

1. Getting Started.....	1
1.1 Parts List.....	1
2. Battery Installation.....	2
2.1 Pool Sensor.....	2
2.1.1 Wrench Usage Instruction.....	9
2.2 Display Console.....	14
3. Features.....	15
3.1 Pool Sensor Features.....	15
3.2 Display Console Features.....	20
3.2.1 Console SET Mode.....	20
3.2.2 Console Alarm Mode.....	23
3.2.3 Console Min/Max Mode.....	26
3.2.4 Console Channel Mode.....	27

3.2.5 Rate of Change Icon.....	29
3.2.6 Temperature Calibration.....	29
4. Sensors Operation Verification.....	35
5. Best Practices for wireless transmit....	35
6. Wireless Pool Sensor Placement.....	37
7. Pool Sensor Maintenance.....	39
8. Specifications.....	40
9. Troubleshooting Guide.....	42

## 1. Getting Started

 **Note:** Power up the pool sensor first, and the Display Console second, don't press any button until all data is received.

### 1.1 Parts List

<b>Display Console:</b>
Size: 4.3"x2.5"x0.65" (11x6.3x1.6cm) LCD Size: 2.1x1.7" (5.3x4.3cm)
<b>Pool transmitter</b>
Size: 6.9x4.2x3.7inch (17.5x10.6x9.5 cm)
<b>2 x Wrench</b> (for Upper lid and Lower lid)
 <b>Note:</b> The pool sensor is very <b>tight for waterproof purpose</b> , please use wrench to open and close it easily.

## 2. Battery Installation

### 2.1 Pool Sensor(Transmitter)

 **Note:** *To avoid permanent damage, please take note of the battery polarity before inserting the batteries.*

 **Note:** *We recommend fresh lithium batteries for sensor temperature lower than -4 °F (-20 °C) in cold weather environments.*

1. **To insert the batteries,** ① Twist the KEY to unlock, ② remove the KEY, and ③ twist the main body of the sensor by removing the upper lid and lower lid with wrench(included), as shown in below image .

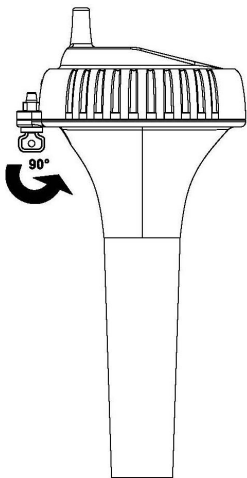

①

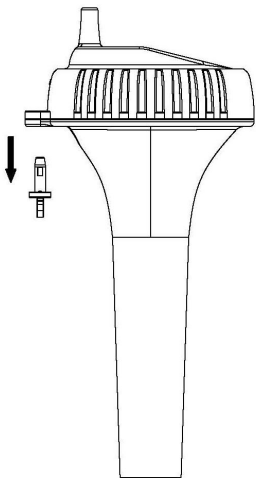

②

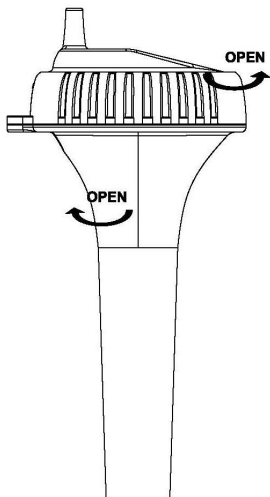
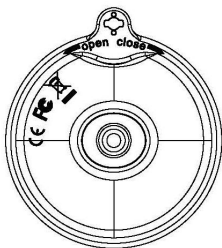

③

 **Note: Refer to Wrench Usage Instructions to open easily along the arrow direction**

## 2. Install 4 x AAA batteries. (Notify Battery polarity)

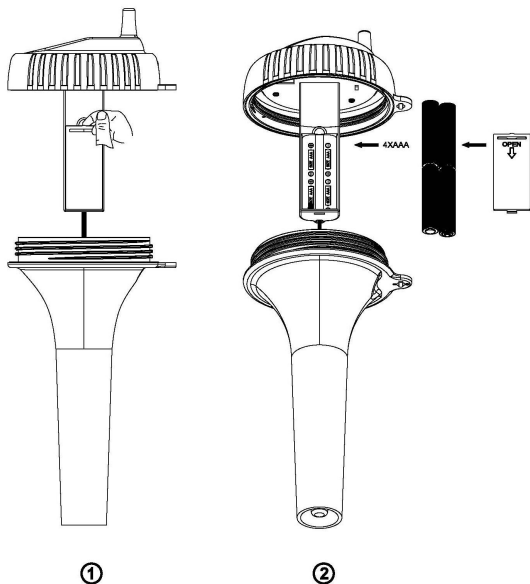

3. **Before Closing battery door.** Make sure both red colored gaskets are properly seated in their traces as shown in below image. *Failure to properly seal the floating thermometer will result in water leakage and damage.*

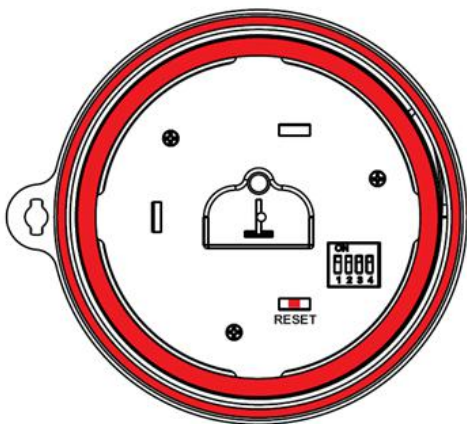



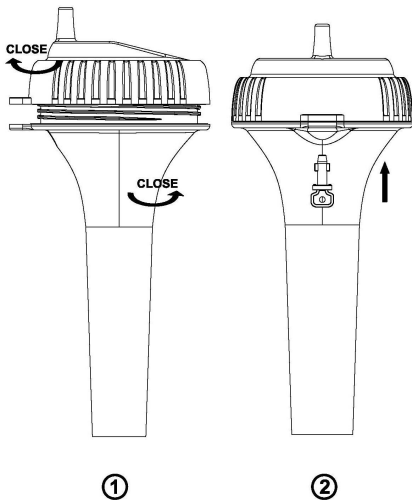

4. **To close the lid,** ① Twist the upper lid and lower lid with **wrench** until it is firmly locked and the key hole is aligned. ② Insert the key and turn 90 degrees to lock the lid, as shown in below image.

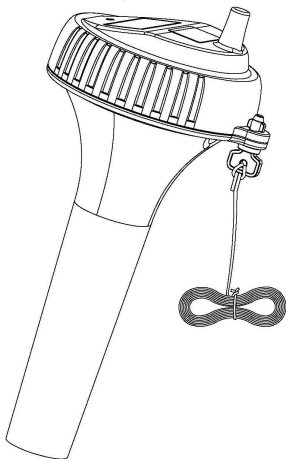

5. **A tether** can be added into the key hole (Tether not included).



 **Note:** Place the sensor in the water and make sure that it is within the effective transmission range( 10” (30 meters) under most conditions) from the display console.

## 2.1.1 Wrench Usage Instructions

Please refer to the following operation.

The wrench has “UP” character facing up.

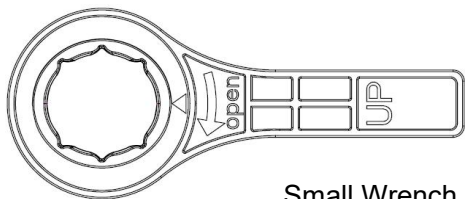

Small Wrench

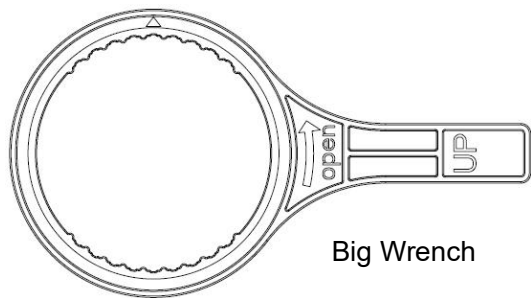

Big Wrench

1. **The small wrench** and the lower cover must be fixed in a tight direction.

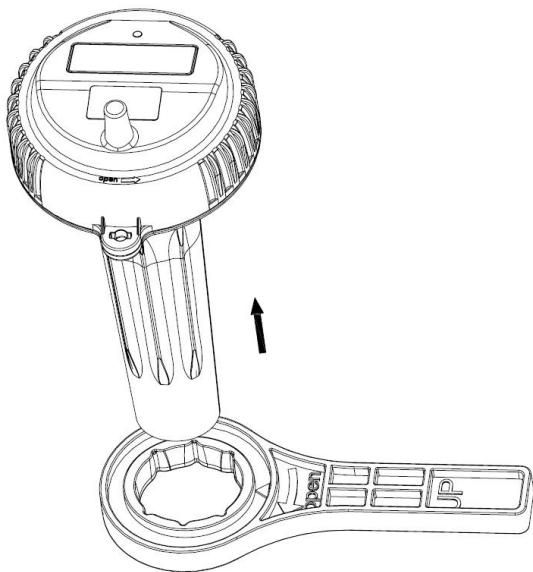

2. **The big wrench** and the upper cover must match tightly, especially the arrow positioning.

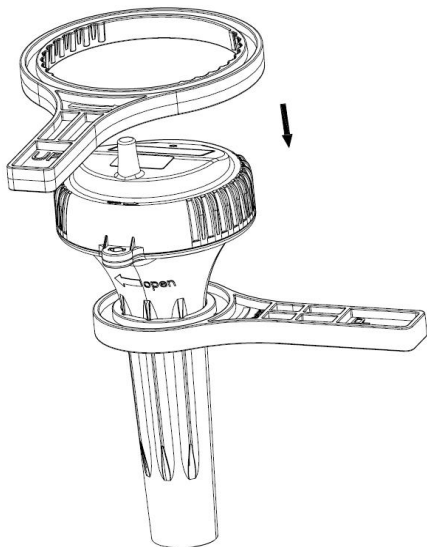



3. **Make sure that the two wrenches** are properly matched to 90 degrees, so that it can be opened easily.

4. **Use the left hand** hold the big wrench to turning the lid counter-clockwise, Tightly grip the small wrench with the right hand.

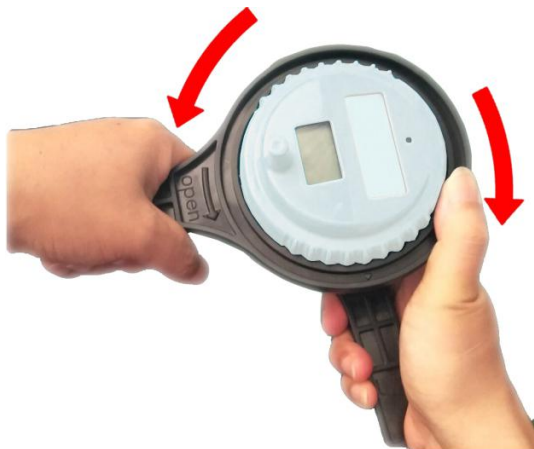

 **NOTE:** You need to hold the big wrench with your right thumb, prevent the big wrench from slipping.

## 2.2 Display Console

1. **Remove** the battery door on the back of the console, as shown in below image.
2. **Insert** 2xAAA (alkaline or lithium, avoid rechargeable) batteries, and close the battery door to put on desk or mount on the wall.
3. **Don't** touch any button until all the data received.

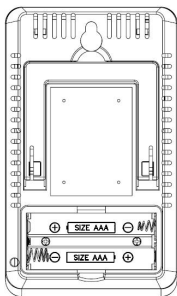

Console Display

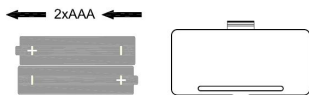



 **Note:** Move the sensor about 5 to 10” (1.5 to 3m) away from the display console (if the sensor is too close, it may not be received by the display console).

 **Note:** If you have more than one remote sensor, make sure they are all powered up and transmitting on different channels.

### **3. Features**

#### **3.1 Pool Sensor Features**

- 1. The Pool sensor** includes dip switches for assigning channel numbers(1-8)
- 2. The pool sensor** includes a reset button. If the display does not power up after inserting the batteries, press the reset button as shown in below image

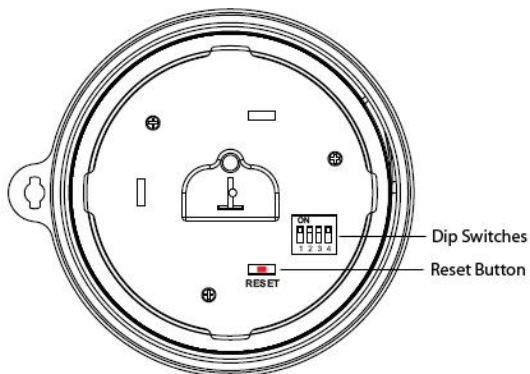

3. **The all four dip switches** displays in the OFF position (factory default setting) in **below image**.

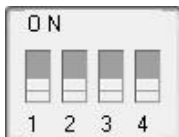

① **Channel Number:** Display console supports up to eight transmitters. To set each channel number (the default is Channel 1), change Dip Switches 1, 2 and 3, as referenced in Table 1.

② **Temperature Units:** To change the transmitter display temp units (°F vs. °C), change Dip Switch 4, as referenced in Table 1.

 ***Note: Take out batteries before change the Channel number and C/F unit, otherwise when batteries installed the switch will not be effective.***

<b>DIP SWITCH</b>				<b>Function</b>
<b>1</b>	<b>2</b>	<b>3</b>	<b>4</b>	
DOWN	DOWN	DOWN	---	Channel 1
DOWN	DOWN	UP	---	Channel 2
DOWN	UP	DOWN	---	Channel 3
DOWN	UP	UP	---	Channel 4
UP	DOWN	DOWN	---	Channel 5
UP	DOWN	UP	---	Channel 6
UP	UP	DOWN	---	Channel 7
UP	UP	UP	---	Channel 8
---	---	---	D O W N	°F
---	---	---	U P	°C

4. **After** inserting the batteries, the remote sensor LED indicator will light for 4 seconds, and then flash every 60 seconds thereafter. Each time it flashes, the sensor is transmitting data.

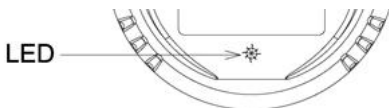

5. **Verify** the correct channel number (CH) and temperature units ( $^{\circ}\text{F}$  vs.  $^{\circ}\text{C}$ ) are on the display, as shown in below image.

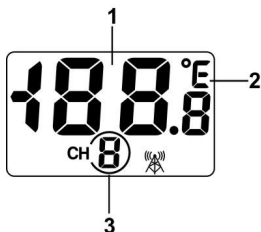

- (1) Temp
- (2) Temp units  
( $^{\circ}\text{F}$  vs.  $^{\circ}\text{C}$ )
- (3) channel number

## 3.2 Display Console Features

**When batteries installed (Don't Press any button)**, the console will instantly display indoor temperature and time. The pool temperature will update on the display within a few minutes on the appropriate channel.

 **Note:** *If the remote does not update, please reference the troubleshooting guide in **Section 9**.*

### 3.2.1 Console SET Mode

 **Note:** *The console has three buttons for easy operation: **SET** button, **MIN/MAX** button, and **CH/+** button.*

To enter the **SET** mode, **press and hold** the SET key for 3 seconds and 12/24 hour format start to flash.

	Short Press <b>SET</b> Key to skip entering into the following features and flash.	Press the <b>[+] or [-]</b> key to set up the following features.
1	12/24 Hour Format	12 hour or 24 Hour Format
2	Hour	Hour value up or down
3	Minute	Minute value up or down

4	Alarm Hour	Alarm Hour value up or down ( <i>While the alarm value is flashing, press and hold the <b>SET</b> button for three seconds to turn alarm ON and OFF. )</i> )
5	Alarm Minute	Alarm Minute value up or down ( <i>While the alarm value is flashing, press and hold the <b>SET</b> button for three seconds to</i>



		<i>turn the alarm ON and OFF. )</i>
6	Temperature Units	°F or °C
7	Max/Min Clearing	ON (Clears Daily) or OFF (Manually)
Press the SET key to exit setting Mode.		

### 3.2.2 Console ALARM Mode

#### 1. Alarm Defaults

Channel	Default Condition	HI ALARM °C(°F)	LOW ALARM °C(°F)
1	OFF	38(100)	15(60)

2	OFF	43(110)	32(90)
---	-----	---------	--------

## 2. View and Set HI/Low Alarm

 **Note:** *The high and low alarms can be set for Channels 1 and 2 only.*

1) **Press** the **CH/+** button to switch the display between Channel 1 and 2.

2) **Next**, press the **SET** button once, the HI/Low alarm and alarm icon **ALARM** will displayed.

3) **Press and hold** the **SET** button for 3 seconds, and the temperature **HIGH (Max)** alarm will flash.

4) **Press** the **[+] or [-]** button to increase or decrease the **HIGH** alarm. **Press and hold** the **[+] or [-]** button to change rapidly. *While the alarm value is flashing, press and hold the **SET** button for three seconds to turn alarm ON and OFF . The alarm icon will appear  when set, and disappear when disabled.*

5) **Press** (do not hold) the **SET** button again to set the **LOW (Min)** temperature alarm. The **LOW** alarm for temperature will flash.

6) **Press** the **[+] or [-]** button to increase or

decrease the **LOW** alarm. **Press and hold** the **[+] or [-]** button to change rapidly. *While the alarm value is flashing, press and hold the **SET** button for three seconds to turn alarm ON and OFF. The alarm icon will appear  when set, and disappear when disabled.*

### **3.2.3 Console Min/Max Mode**

1) In normal mode, Press the **MIN/MAX** button once and the MAX arrow will flash. Press the **MIN/MAX** button again and the MIN arrow will flash.

2) Press the **MIN/MAX** button again to return to normal mode.

3) To reset the Max/Min values, **press and hold** the **MIN/MAX-** button for 3 seconds.



### **3.2.4 Console Channel Mode**



#### **1. Channel Selection**

Press the **CH/+** button to switch the display between remote sensors 1 through 8, and scroll mode . In scroll mode, all of detected outdoor sensors will be displayed in five second intervals.

#### **2. Sensor Search Mode**

If any of the sensor communication is lost, **dashes (---)** will be displayed on the screen. To reacquire the signal:

1) If a specific channel is lost, press the **CH/+** button to display this channel, then **Press and hold** the **CH/+** button for 3 seconds, and remote search icon  will be constantly displayed for up to 3 minutes. Once the signal is reacquired, the remote search icon  will turn off, and the current values will be displayed.

2) If new sensors are added, subtracted, or multiple sensor channels are lost, **Press and hold** the **CH/+** button for 5 seconds (on any channel), and remote search icon  will be constantly displayed for up to 10 minutes. Once the signal is reacquired, the remote search icon  will turn off, and the current values will be displayed.

### 3.2.5 Rate of Change Icon

The rate of change icon  detects rapid changes of remote temperature. If the arrow points upward, the temperature is increasing at a rate of  $+2^{\circ}\text{C}(4^{\circ}\text{F})$  per 30 minutes (or greater), If the arrow points downward, the temperature is decreasing at a rate of  $-2^{\circ}\text{C}(4^{\circ}\text{F})$  per 30 minutes (or less).

### 3.2.6 Temperature Calibration

#### 1. Pool Sensor Temp Calibration

1) Prior to entering the calibration mode, press the **CH/+** button to select the pool temperature sensor(CH1-8) you wish to adjust.

2) To enter the temperature calibration mode, press and hold the **SET** and **CH/+** buttons at the same time for 5 seconds and the pool temperature value will begin flashing. *Press the **CH/+** button to increase the temperature and the **MIN/MAX** button to decrease the temperature reading in 0.1° increments. To rapidly increase (or decrease) the temperature reading, press and hold the **CH/+** or **MIN/MAX** button.*

3) To return the temperature to the actual or uncalibrated measurement, press the **SET** button.

4) Once the displayed temperature equals the calibrated source, **press and hold** the



**SET** button for three seconds, or wait 15 seconds for timeout, and the temperature value will stop flashing.

## **2. Indoor Temperature Calibration**

1) To enter the indoor temperature calibration mode, press and hold the **SET** and **MIN/MAX** buttons at the same time for 5 seconds and the IN temperature value will begin flashing. *Press the **CH/+** button to increase the temperature and the **MIN/MAX** button to decrease the temperature reading in 0.1° increments. To rapidly increase (or decrease) the temperature reading, press and hold the **CH/+** or **MIN/MAX** button.*

2) To return the temperature to the actual or uncalibrated measurement, press the **SET** button.

3) Once the displayed temperature equals the calibrated source, **press and hold** the **SET** button for three seconds, or wait 15 seconds for timeout, and the temperature value will stop flashing.

 **Note:** *The calibrated value can only be adjusted on the console. The remote sensor always displays the un-calibrated or measured value.*

*The purpose of calibration is to fine tune or correct for any sensor error associated*

*with the devices margin of error. The measurement can be adjusted from the console to calibrate to a known source.*

*Calibration is only useful if you have a known calibrated source you can compare it against, and is optional. This section discusses practices, procedures and sources for sensor calibration to reduce manufacturing and degradation errors. Do not compare your readings obtained from sources such as the internet, radio, television or newspapers. They are in a different location and typically update once per hour.*

*The purpose of your weather station is to*

*measure conditions of your surroundings, which vary significantly from location to location.*

 **Discussion:** *Temperature errors can occur when a sensor is placed too close to a heat source (such as a building structure, the ground or trees).*

*To calibrate temperature, we recommend a mercury or red spirit (fluid) thermometer. Bi-metal (dial) and other digital thermometers are not a good source and have their own margin of error. Using a local weather station in your area is also a poor source due to changes in location, timing (airport weather stations are only*

*updated once per hour) and possible calibration errors (many official weather stations are not properly installed and calibrated).*

#### **4. Sensor Operation Verification**

**Verify** the indoor and sensor temperature match closely with the console and sensor array in the same location (about 1.5 to 3meters apart). The sensors should be within 2°C/4°F (the accuracy is  $\pm 1^{\circ}\text{C}/2^{\circ}\text{F}$ ). Allow about 30 minutes for both sensors to stabilize.

#### **5. Best Practices for Wireless Transmit**

**Wireless communication** is susceptible to interference, distance, walls and metal

barriers. We recommend the following best practices for trouble free wireless communication.

**1. Electro-Magnetic Interference (EMI).**

Keep the console several feet away from computer monitors and TVs.

**2. Radio Frequency Interference (RFI).**

If you have other 433 MHz devices and communication is intermittent, try turning off these other devices for troubleshooting purposes. You may need to relocate the transmitters or receivers to avoid intermittent communication.

**3. Line of Sight Rating.** This device is rated at 50meters line of sight (no interference, barriers or walls) but typically

you will get 30meters maximum under most real-world installations, which include passing through barriers or walls.

4. **Metal Barriers.** Radio frequency will not pass through metal barriers such as aluminum siding. If you have metal siding, align the remote and console through a window to get a clear line of sight.

## **6. Wireless Pool Sensor Placement**

1. **Place** the sensor in the pool or spa within 30meters of the display console (**Reference A**). Avoid transmitting through solid earth or ground (**Reference B**).

2. **Place** the console at least three feet away from computers, TVs and wireless phones.

### 3. **Avoid** transmitting through solid metal barriers.

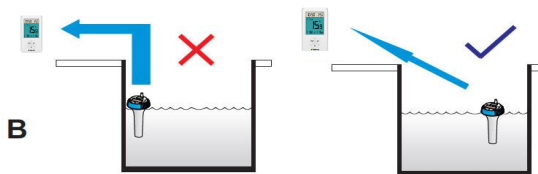
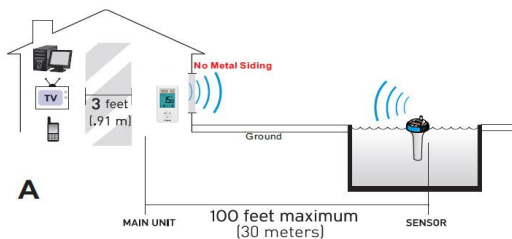



## 7. Pool Sensor Maintenance

During each battery change (1-2 years), we recommend applying waterproof silicon grease to the seals:

[http://en.wikipedia.org/wiki/Silicone\\_grease](http://en.wikipedia.org/wiki/Silicone_grease)

Silicone grease is available at most hardware and pool stores.



**Note:** *Not recommended for covered spas. Wireless signal will not penetrate solid metal or earth.*

## 8. Specifications

### 1. Wireless Specifications

- 1) Line of sight wireless transmission (in open air): 165 feet (50m), 100 feet (30m) under most conditions.
- 2) Frequency: 433 MHz
- 3) Update Rate: 60 seconds

### 2. Measurement Specifications

<b>Measurement</b>	<b>Range</b>	<b>Accuracy (Resolution)</b>
Indoor Temperature	32 to 140 °F (0°-60°C)	±2°F/±1°C (0.1 °F/°C)
Outdoor Temperature	-40 to 140 °F (-40°-60°C)	±2°F/±1°C (0.1 °F/°C)

### **3. Power Consumption**

**Base station (display console):** 2 x AAA 1.5V Alkaline or Lithium batteries (not included)

**Pool sensor:** 4 x AAA 1.5V Alkaline or Lithium batteries (not included)



**Battery life:** Minimum 12 months for base station. Intermittent reception and multiple sensors may reduce the battery life.

Minimum 12 months for pool sensor (use lithium batteries in cold weather climates less than -4 °F/-20°C)

## 9. Troubleshooting Guide

**Wireless remote (thermometer) not reporting in to console. There are dashes (---) on the display console.**

### **Solution**

**If any of the sensor communication is lost, dashes (---) will be displayed on the screen. To reacquire the signal, press and hold the **CH/+** button for 3 seconds, and the remote search icon  will be constantly displayed. Once the signal is reacquired, the remote search icon  will turn off, and the current values will be displayed.**

**The maximum line of sight transmit**

range is 165'(50m) and 100'(30m) under most conditions. Move the sensor assembly closer to the display console.

**If the sensor assembly** is too close (less than 5'/1.5m), move the sensor assembly away from the console.

Make sure the remote sensor LCD display is working and the transmitter light is flashing once per 60 seconds.

**Install a fresh set of batteries** in the remote thermometer. For cold weather environments, install lithium batteries.

**Make sure the remote sensors** are not

transmitting through solid metal (acts as an RF shield), or earth barrier (down a hill).

**Move the display console** around electrical noise generating devices, such as computers, TVs and other wireless transmitters or receivers.

**Move the remote sensor** to a higher location. Move the remote sensor to a closer location.

**Indoor and Outdoor Temperature do not agree**

**Solution**

Allow up to one hour for the sensors to

stabilize due to signal filtering. The indoor and outdoor temperature sensors should agree within 4°F/2°C(the sensor accuracy is ±2°F/1°C).

Use the calibration feature to match the indoor and outdoor temperature to a known source.

**Display console contrast is weak**

**Solution**

Replace console batteries with a fresh set of batteries.

